

# CHAINSAW SCABBARD ASSEMBLY INSTRUCTIONS

Figure 1

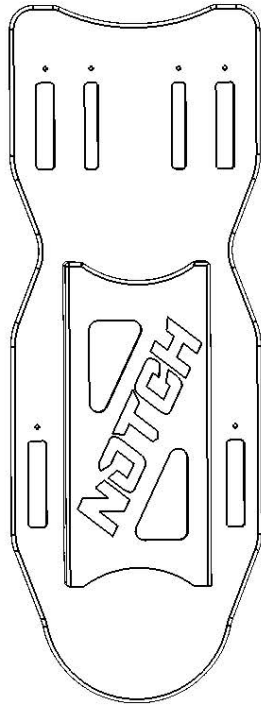

Figure 2

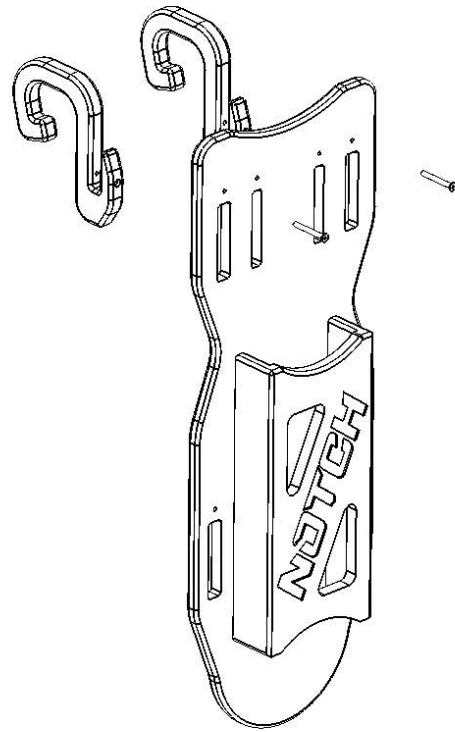

Figure 3

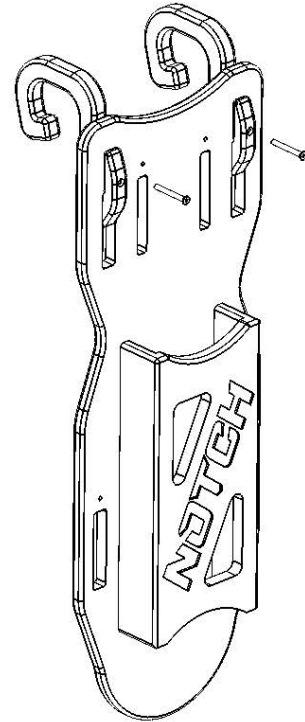
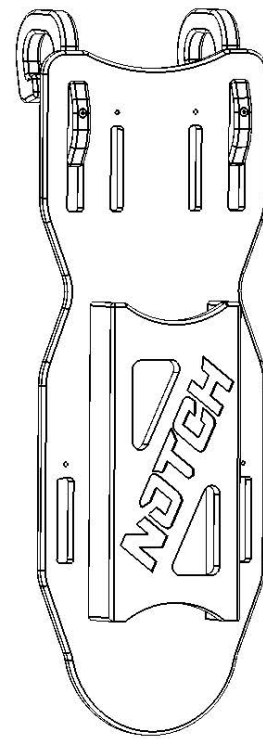

Figure 4



## INSIDE MOUNT

1. Locate main frame (Figure 1)
2. Align inside hooks (A) with the outside set of cut slots in the main frame (Figure 2)
3. Attach hooks to the main frame ensuring alignment of the screw holes (Figure 3)  
Note: may require mild tap with rubber mallet
4. Using provided stainless steel screws secure hooks to the main frame (Figure 4)

## INSTALLATION

Hang scabbard on the inside of the bucket basket ensuring hooks are resting on basket rim

Components:

Inside hooks & screws (A)

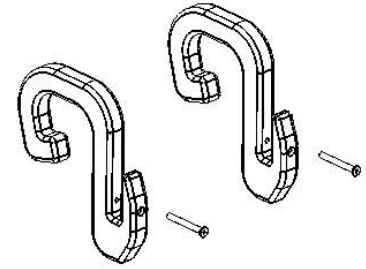

Outside hooks & screws (B)

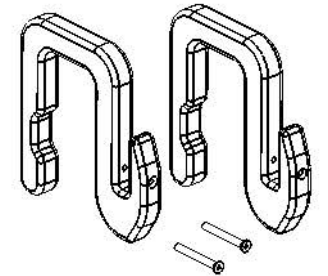

Figure 7

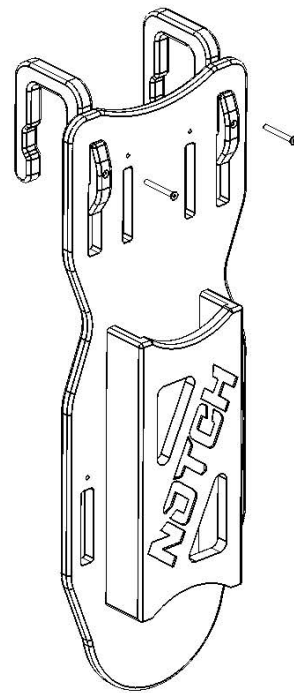

Figure 8

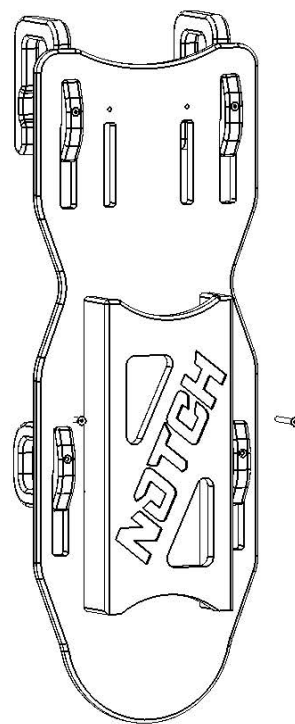

Figure 9

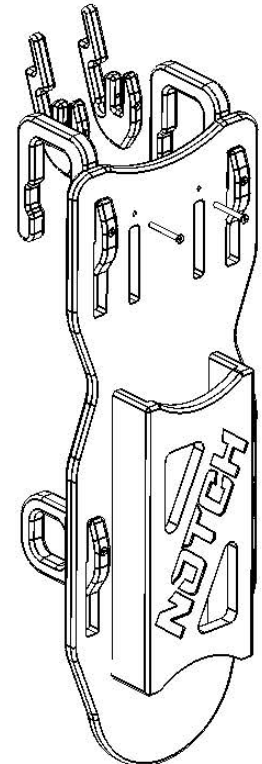
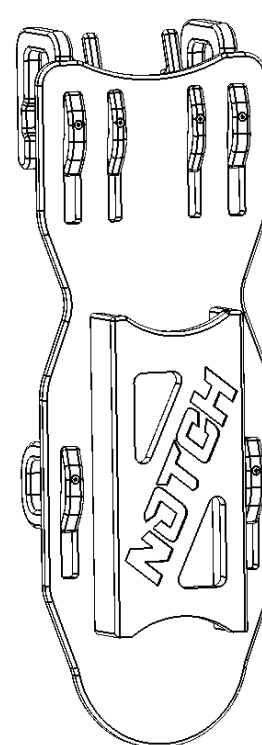

Figure 10



## OUTSIDE MOUNT

1. Locate main frame (Figure 1)
2. Attach outside hooks (B) to the outside set of cut slots in the main frame (Figure 7) ensuring proper screw alignment
3. Attach outside bump stops (D) to the main frame (Figure 8)
4. Attach outside tabs (C) to the inside set of cut slots in the main frame (Figure 7) ensuring proper screw alignment
5. Tighten all connections (Figure 10)

Note: Some connections may require mild tap with rubber mallet

## INSTALLATION

Hang scabbard on the outside of the bucket basket ensuring outside tabs are positioned under the basket rim

Outside tabs & screws (C)

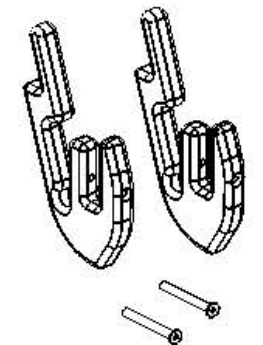

Outside bump stops & screws (D)

