

CHAINSAW SCABBARD ASSEMBLY INSTRUCTIONS

Figure 1

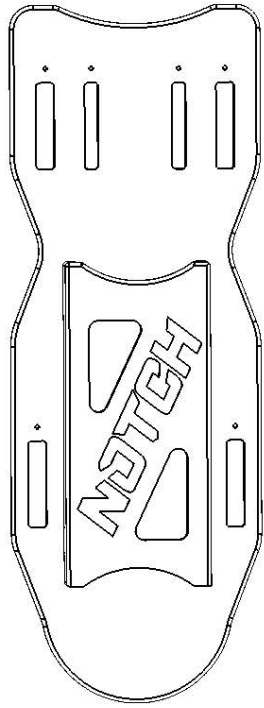

Figure 2

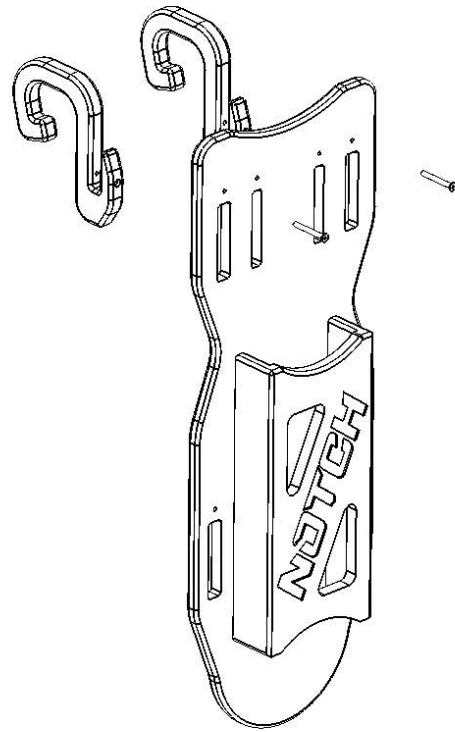

Figure 3

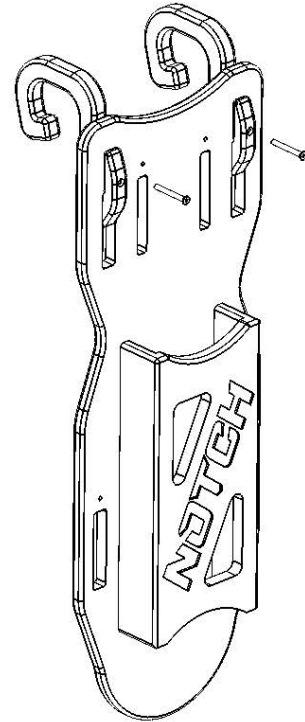
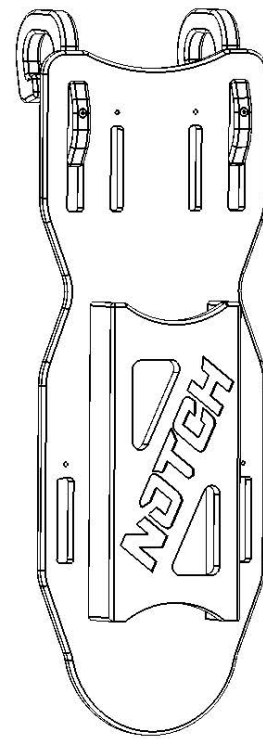

Figure 4



INSIDE MOUNT

1. Locate main frame (Figure 1)
2. Align inside hooks (A) with the outside set of cut slots in the main frame (Figure 2)
3. Attach hooks to the main frame, align screw holes (Figure 3) Note: may require mild tap with rubber mallet
4. Use provided stainless steel screws secure hooks to the main frame (Figure 4)

Components:

Inside hooks & screws (A)

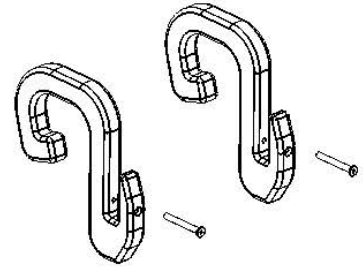

Outside hooks & screws (B)

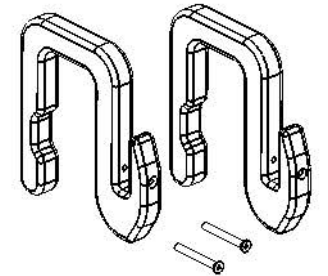

Figure 7

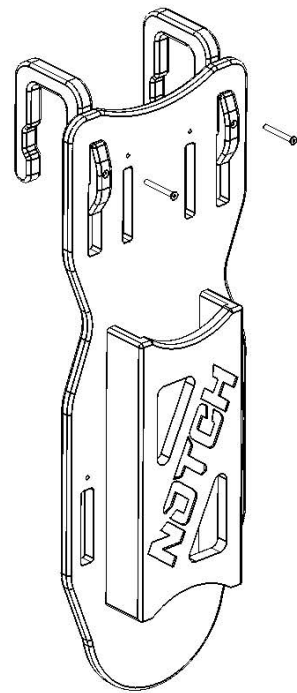
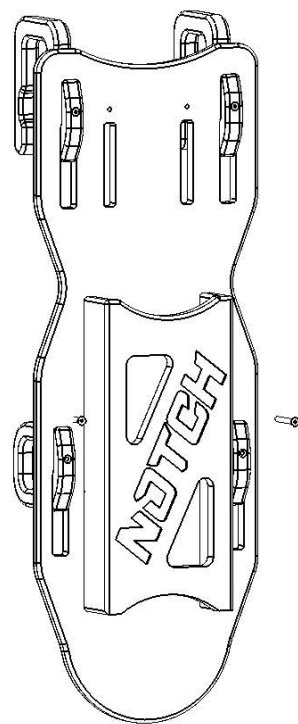

Figure 8



OUTSIDE MOUNT

1. Locate main frame (Figure 1)
2. Remove 2 outside hooks & 2 screws (B) from packaging
3. Attach hooks in the outside set of cut slots in the main frame (Figure 7)
4. Attach outside bump stops (D)
5. Connect top handle () to middle frame tension () with (2) shaped bolts () (and should be acin to a ds the ope ato)
6. Tighten and check all connections

Outside tabs & screws (C)

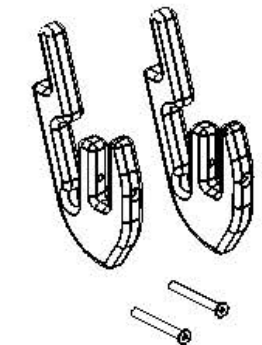

Inside bump stops & screws (D)

